

## Optima® EAF-150 Faucet

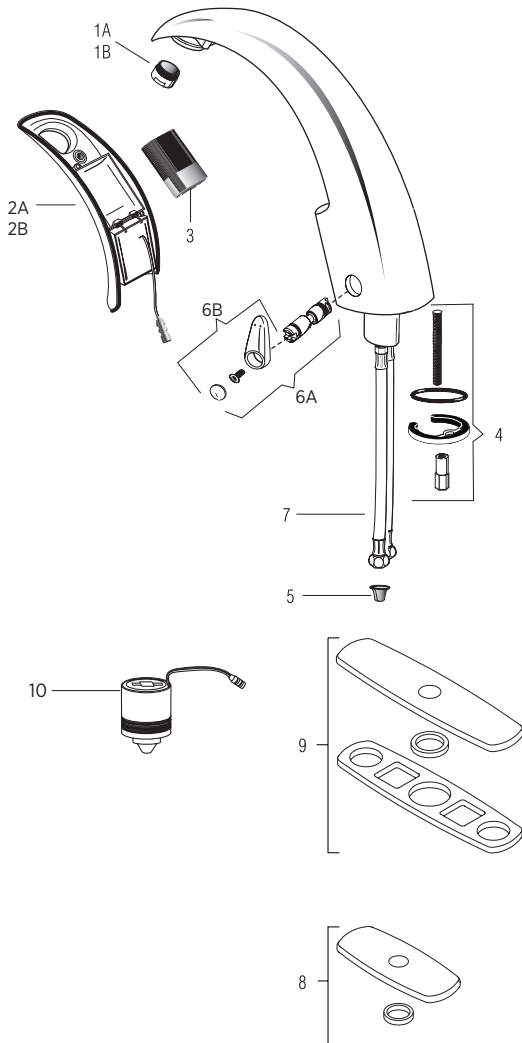

### PARTS LIST—EAF-150 FAUCETS

Item No.	Code No.	Part No.	Description
1A.	<b>0335008</b>	EAF-10	2.2 gpm (8.3 Lpm) Aerator Spray Head
1B.	<b>0335010</b>	EAF-12	0.5 gpm (1.9 Lpm) Spray Head (Multi-Lam)
1C.	<b>0335029</b>	EAF-51	0.35 gpm (1.3 Lpm) Spray Head (Multi-Lam)
1D.	<b>0335021</b>	EAF-22	1.5 gpm (5.6 Lpm) Aerator Spray Head
2A.	<b>0335002</b>	EAF-3-A	Throat Plate Assembly (Battery Models) (from Nov 2018)
2B.	<b>0335003</b>	EAF-4-A	Sensor standard throat plate assembly with i.q. click (IC variation)
3.	<b>3335009</b>	EAF-1000	Battery Replacement Kit (6V 2CR5 with 2.5 mm allen Wrench)
4.	<b>0335000</b>	EAF-1	Faucet Mounting Kit
5.	<b>0335007</b>	EAF-9	Strainer (Filter) 2 required for ISM Models (one per package)
6A.	<b>3335118</b>	EAF-1022	Mixer Handle Assembly and Cartridge (post 2004)
6B.	<b>3335011</b>	EAF-1002	Handle Repair Kit
7.	<b>3335023</b>	EAF-1008	15" (330 mm) Flexible Supply Hose (1) with inlet filter
8.	<b>0362011</b>	SFP-11	Trim Plate for 4" Center-set Sink
9A.	<b>3365303</b>	ETF-608-A	Trim Plate for 8" Center-set Sink
9B.	<b>3362022</b>	SFP22A	Trim Plate for 8" Centerset sink
10.	<b>0335001</b>	EAF-2	Solenoid (6 mm hex recess)

EAF-1001 Mixer Handle Assembly & Cartridge Discontinued (Faucets manufactured prior 2004).  
Use Mixer Handle Assembly Cartridge kit EAF-1022-A (Faucets manufactured post 2004).

## Optima® EAF-150 Faucet

### AUTO SENSOR CALIBRATION OR RANGE ADJUSTMENT

For sensor recalibration, press and release iq button 2 quick times, wait for rapid “temporary off” red LED flashes, then press and hold iq button for several seconds and after four (4) slow red LED flashes, release button and step away for fifteen (15) seconds to allow faucet sensor to recalibrate.

After water turns on then off and red LED flashes are followed by a single green flash (calibration complete), test faucet.

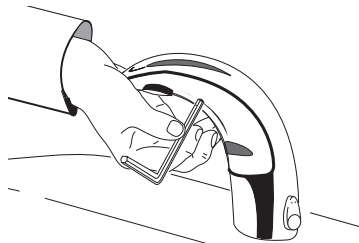

STANDARD MODELS

### MANUAL RANGE ADJUSTMENT

To manually change range, press and release iq button 2 quick times, wait for rapid “temporary off” red LED flashes, then press and hold iq button, there will be four (4) red LED flashes, a pause, then more red LED flashes (up to eight (8) red LED flashes); 1-red LED flash for the shortest range setting, eight (8) flashes for the longest range setting;

Release iq button after desired red LED flash for range setting (#6 is factory setting).

After releasing button, faucet will cycle through auto calibration (approximately 15-seconds). Then test faucet.

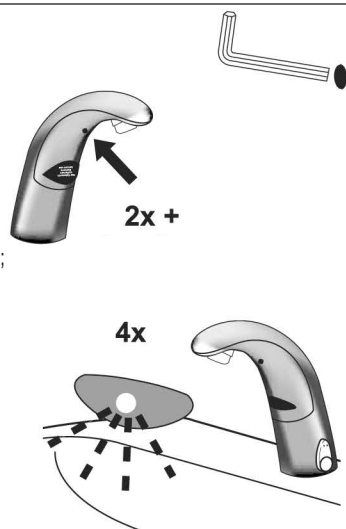

1 x ( 1x, 2x,...,8x)

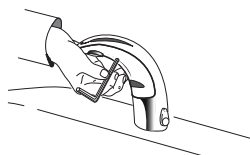

**NOTE:** Updated electronics have visible RED and GREEN LED. Original electronics have only RED LED and range setting is reversed (1 = longest, 8 = shortest)

### BATTERY REPLACEMENT

Replace battery when RED LED indicator flashes each time faucet is in use or when faucet stops functioning.

#### Step 1

Close supply stop(s).

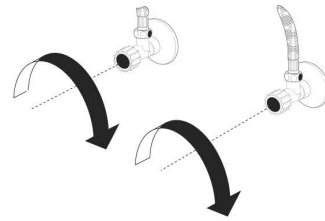

#### Step 2

Loosen screw with hex wrench. Remove throat plate. Disconnect electrical lead at connector if required.

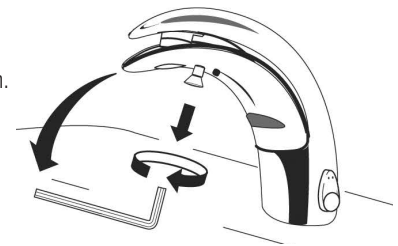

#### Step 3

Remove battery cover using a No. 1 Phillips head screwdriver. Remove old battery. Dispose of properly.



#### Step 4

Wait three (3) minutes before inserting new battery.



#### Step 5

Insert a new 6 volt type 2CR5 lithium battery. The RED LED will flash for one (1) minute.

Reinstall battery cover.

Reconnect electrical lead at connector if previously disconnected. Reinstall throat plate.

If LED doesn't flash or if it just lights up, remove the battery. Wait three (3) minutes, then reinsert the battery.

If water flows continuously after inserting the new battery and opening the supply stops, remove the battery. Wait three (3) minutes, then reinsert the battery.

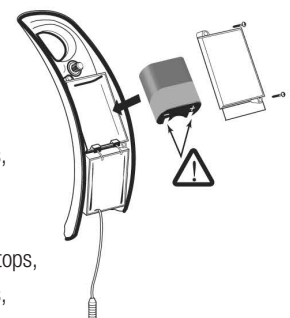

#### Step 6

Open supply stops.

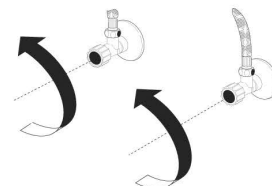

## Optima® EAF-150 Faucet

### SERVICE OPERATION

#### Prepare for operation

(A) When activating a new faucet (or new sensor replacement) for the first time, after removing protective label from sensor window, press sensor button one (1) time, then place hand or installation instructions within 1 to 2 inches in front of sensor until faucet activates water flow, remove hand or instructions,

water flow stops, red LED flashing ends followed with one (1) Green LED flash (approximately 12 seconds) Test faucet.

**If waterflow DOES NOT start after removing the sticker and the RED LED within the sensor flashes continue with the following procedure!!**

Place installation instructions within 1 to 2 inches in front of sensor until faucet activates water flow, then remove instructions, water flow stops, red LED flashing ends followed with one (1) Green LED flash (approximately 12 seconds). Test faucet.

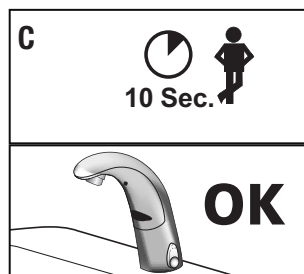
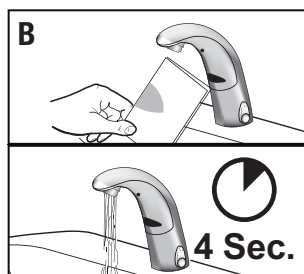
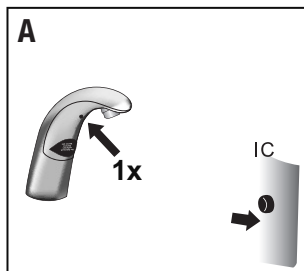
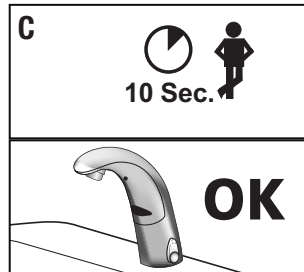
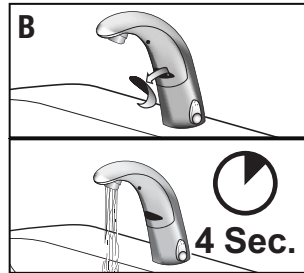
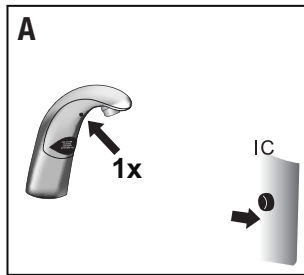

### TROUBLESHOOTING GUIDE

#### 1. Problem: Faucet not activating after installation.

Cause: Not properly started up. See step 5 on previous page.  
 Solution: Remove adhesive label from sensor eye.  
 Solution: Press button on faucet throat one time.

#### 2. Problem: Faucet delivers water in an uncontrolled manner.

Cause: Faucet is not working properly.  
 Solution: Contact the Sloan Technical Support at +1.888.756.2614.

#### 3. Problem: Faucet does not deliver any water when Sensor is activated.

Indicator: Solenoid valve produces an audible "CLICK."  
 Cause: Water supply stop(s) closed.  
 Solution: Open water supply stop(s).  
 Cause: Water supply stop strainer(s) clogged.  
 Solution: Clean water supply stop strainer(s).  
 Indicator: Solenoid valve DOES NOT produce an audible "CLICK."  
 Cause: Battery low (EAF-150 Models).  
 Solution: Replace battery (refer to Battery Replacement on Previous page).  
 Cause: Power failure (EAF-100 Models).  
 Solution: Check power supply.

#### 4. Problem: Faucet delivers only a slow flow or dribble when Sensor is activated.

Cause: Water supply stop(s) are partially closed.  
 Solution: Completely open water supply stop(s).  
 Cause: Water supply stop strainer(s) clogged.  
 Solution: Remove, clean, and reinstall water supply stop strainer(s). Replace strainer(s) if required.  
 Cause: Aerator is clogged.  
 Solution: Remove, clean, and reinstall Aerator. Replace Aerator if required.  
 Cause: Faucet is not working properly.  
 Solution: Contact the Sloan Valve Company Installation Engineering Department (see below).

#### 5. Problem: Faucet drips between uses or runs on. Solenoid is heard activating

Cause: Debris caught in solenoid  
 Solution: Clean Solenoid Valve - Turn off water, remove and unplug sensor/throat plate assembly with 2.5-mm hex wrench, remove solenoid using 6-mm hex wrench, clean solenoid diaphragm of plumbing debris, clean solenoid base in faucet with a dry towel, install solenoid (do not over-tighten), connect sensor/throat plate and install, dry fire solenoid (listen for clicking), then turn on water and test faucet. Also flush lines at stops as well to remove any plumbing debris in the line, check supply hose filters at that time as well.

#### 6. Problem: LED indicator blinks when Faucet is in use.

Cause: Battery low (EAF-150 Models).  
 Solution: Replace battery (refer to Battery Replacement on Previous Page)

#### 7. Problem: i.q. - doesn't function (-IC models only)

Cause: Button is not working properly.  
 Solution: Replace sensor throat plate; see parts breakdown on next page for correct sensor throat plate replacement (item #2B).

#### 8. Problem: The water temperature is too hot or too cold on a Faucet connected to hot and cold supply lines.

CAUSE: Supply Stops are not adjusted properly.  
 SOLUTION: Adjust Supply Stops.  
 CAUSE: For models with integral mixing valve - Mixing valve is set improperly for the water temperature desired.  
 SOLUTION: Rotate mixing valve handle clockwise to decrease water temperature or counterclockwise to increase water temperature.