

PWT MCR 4011-AL/MCR 4001-AL SERIES CONTROLLER INSTALLATION INSTRUCTIONS

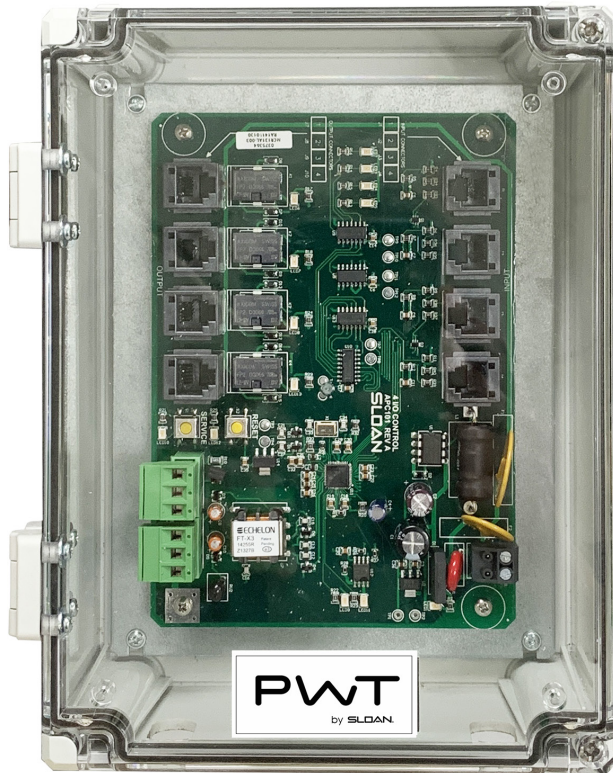

PWT MCR 4011-AL/MCR 4001-AL CONTROLLER

Installation of the PWT MCR 4011-AL/MCR 4001-AL Series Controller incorporates the latest advances in microprocessor technology to provide maximum control of your plumbing system. PWT patented sensing and metering products can be programmed to do just about anything you require, when you require it, including the ability to Delay and Lock-Out fixture activation. PWT products control showers, water closets, lavatory and combination fixtures and help maintain operation of ON/OFF/DELAY. These modular, flexible systems for new retrofit or expansion applications, have few moving parts, no mechanical metering devices, and operate on low voltage to ensure safety and reliability. The following instructions will serve as a guide when installing the MCR 4011/4001 Series Controller. As always, good safety practices and care are recommended when installing your new controller. If further assistance is required contact your nearest Sloan PWT Representative office.

LIMITED WARRANTY

Unless otherwise noted, Sloan Valve Company warrants its products, manufactured and sold for commercial or industrial uses, to be free from defects of material and workmanship for a period of three (3) years (one year for SF faucets, special finish and PWT electronics and 30 days on PWT software) from the date of first purchase. During this period, Sloan Valve Company will, at its option, repair, replace, or refund the purchase price of any produce which fails to conform with this warranty under normal use and service. This shall be the sole and exclusive remedy under this warranty. Products must be returned to Sloan Valve Company, at customer's cost. No claims will be allowed for labor, transportation or other costs. This warranty extends only to persons or organizations that purchase Sloan Valve Company's products directly from Sloan Valve Company for purpose of resale.

THERE ARE NO WARRANTIES WHICH EXTEND BEYOND THE DESCRIPTION ON THE FACE HEREOF. IN NO EVENT IS SLOAN VALVE COMPANY RESPONSIBLE FOR ANY CONSEQUENTIAL DAMAGES OF ANY MEASURE WHATSOEVER.

Prior to Installation

PRIOR TO INSTALLATION

Before you install the MCR series controller, be sure the items listed below are installed.

- 24 VAC step down transformer
- Push buttons
- Flushometer
- Lavatory/Shower solenoids

IMPORTANT

- **ALL PLUMBING SHOULD BE INSTALLED IN ACCORDANCE WITH APPLICABLE CODES AND REGULATIONS.**
- **WATER SUPPLY LINES MUST BE SIZED TO PROVIDE AN ADEQUATE VOLUME OF WATER FOR EACH FIXTURE.**
- **FLUSH ALL WATER LINES PRIOR TO MAKING CONNECTIONS.**
- **ALL ELECTRICAL WIRING IS TO BE INSTALLED IN ACCORDANCE WITH NATIONAL/LOCAL CODES AND REGULATIONS.**

1. Mounting Controller

1. Loosen the polycarbonate screws.
2. Open polycarbonate cover in front of controller.
3. Install controller so that all cables enter from the bottom. Controller must be located within 200 ft. from furthest push button and within 200 ft. of power supply transformer.
4. Mount controller to wall using mounting screws and plastic anchors (supplied by others).

NOTE: Extension cables are available as an option from PWT to allow for installing the controller up to 35 ft from furthest push button.

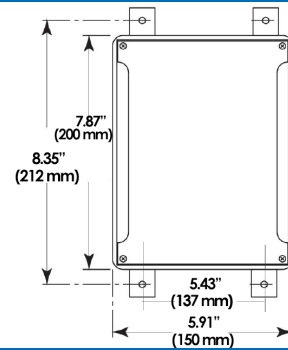

2. Power Supply Connection

1. Make sure power is off to 24 VAC transformer.
2. Run 18-gauge wire from secondary side (24 VAC output) of transformer to terminal block inside controller.
3. Turn power on and look for power indicator to illuminate.
4. Turn power off until pushbuttons and solenoids are installed.

IMPORTANT: Be sure that wire is completely inserted into terminal and that no strands are crossing from one side to the other.

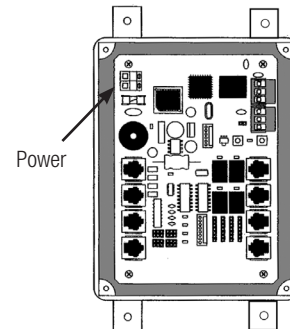

3. Push Buttons and Solenoid Connections

1. Plug RJ-II connectors from push buttons into appropriate input connections in controller. Refer to program type section of these instructions.
2. Plug RJ-II connectors from flushometers, lavatories and/or shower solenoids into appropriate output connections in controller. Refer to program type section of these instructions.
3. Power up controller.

IMPORTANT: Make sure that all pushbuttons are connected to the input and solenoids connected to output. Improper connections will result in failure of controller and/or push buttons and solenoids and will require replacement.

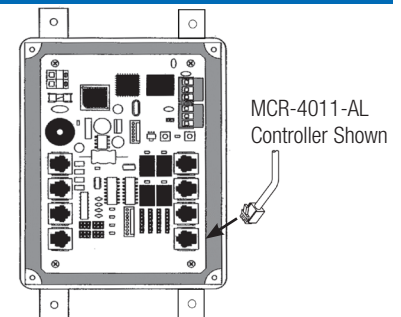

4. Network Connections

1. Remove the male ends of the two green terminal connections from controller.
2. Take the incoming network twisted pair wire and insert one wire into position 1 and 2 of the male terminal ends and tighten screw.
3. Plug male terminal into either of the female connections on controller.
4. Take outgoing network twisted pair wire and repeat steps 2 and 3.

NOTE: Refer to communication network installation for detailed wiring.

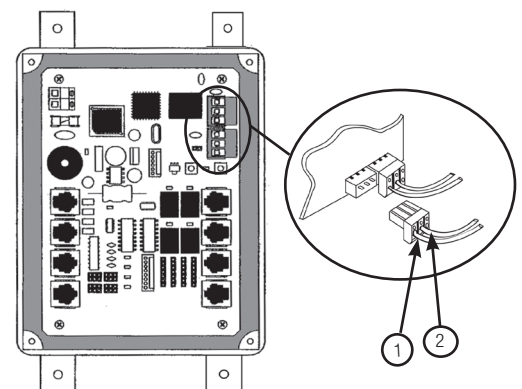

5. Test Controller

1. Activate pushbuttons one at a time to test for correct wiring of controller. Use pushbutton and solenoid LEDs to confirm proper pushbutton and solenoid locations.
2. Test communications (if applicable) from computer using PWT Network Manager software.
3. Close the polycarbonate cover. Tighten two cover screws

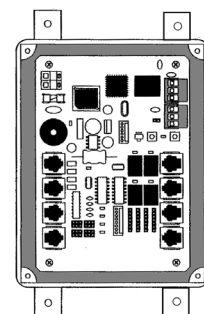

Type Description

Water Closet Type A

When the water closet pushbutton is pressed, a signal is transmitted to the control board requesting a flush. If the request is valid, the flush cycle is started. There will be a random 1 - 60 second delay before a flush, the flush occurs, and then a -60 second delay after the flush. If three flush cycle attempts are made within five minutes of the first flush cycle, the flushometer will "Lock Out" for a period of 30 minutes. During this time the "Service" LED will blink 'ON' and 'OFF' at ten second intervals, signaling a violation of the flushometer. When the "LOCK OUT" time expires, the "Service" LED will turn 'OFF' and the flushometer will return to normal operation.

Water Closet Type B

When the water closet pushbutton is pressed, a signal is transmitted to the control board requesting a flush. If the request is valid, the flush cycle is started. There will be a random 1 - 60 second delay before a flush, the flush occurs, and then a 0- 60 second delay after the flush. If three flush cycle attempts are made within five minutes of the first flush cycle, the flushometer will "Lock Out" for a period of 60 minutes. During this time the "Service" LED will blink 'ON' and 'OFF' at ten second intervals, signaling a violation of the flushometer. When the "Lock Out" time expires, the "Service" LED will turn 'OFF' and the flushometer will return to normal operation.

Hot Water Type A

When the hot water pushbutton is pressed, the hot water solenoid will activate for 10 seconds. If the hot water pushbutton is activated a second time within the 10 seconds, the hot water will turn off. Repeated operations are unlimited.

Hot Water Type B

When the hot water pushbutton is pressed, the hot water solenoid will activate for 20 seconds. If the hot water pushbutton is activated a second time within the 20 seconds, the hot water will turn off. Repeated operations are unlimited.

Cold Water Type A

When the cold water pushbutton is pressed, the cold water solenoid will activate for 10 seconds. If the cold water pushbutton is activated a second time within the 10 seconds, the cold water will turn off. Repeated operations are unlimited.

Cold Water Type B

When the cold water pushbutton is pressed, the cold water solenoid will activate for 20 seconds. If the cold water pushbutton is activated a second time within the 20 seconds, the cold water will turn off. Repeated operations are unlimited.

Shower Type A

When the shower pushbutton is pressed, the shower solenoid will activate for 5 minutes. If the shower pushbutton is activated a second time within the 5 minutes, the shower will turn off. A lockout of 20 seconds will occur after the shut off.

Shower Type B

When the shower pushbutton is pressed, the shower solenoid will activate for 3 minutes. If the shower pushbutton is activated a second time within the 3 minutes, the shower will turn off. A lockout of 20 seconds will occur after the shut off.

Shower Type C

The first time the shower pushbutton is pressed, the shower solenoid will activate for 30 seconds. If the shower pushbutton is activated a second time within the 30 seconds, the shower will turn off. A minimum 30-second delay will occur before the next activation. The second activation will activate the shower solenoid for 60 seconds (this is to be 200% of the first activation run time). A lockout of 120 seconds will occur after the second activation.

Shower Type D

The first time the shower pushbutton is pressed, the shower solenoid will activate for 60 seconds. If the shower pushbutton is activated a second time within the 60 seconds, the shower will turn off. A minimum 30-second delay will occur before the next activation. The second activation will activate the shower solenoid for 120 seconds (this is to be 200% of the first activation run time). A lockout of 120 seconds will occur after the second activation.

Program Type Section

This section outlines how to read and determine a type number for a four I/O control board module.

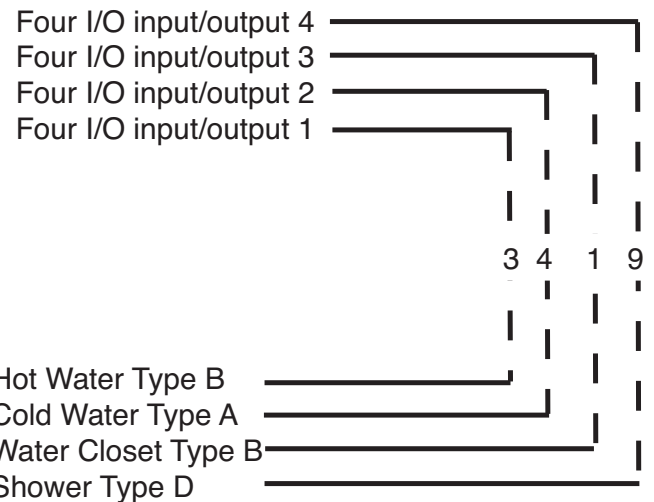

When assistance is required, please contact Sloan Valve Company Installation

Engineering Department at:

1-888-SLOAN-14 (1-888-756-2614) OR 1-847-233-2016

SLOAN • 10500 SEYMOUR AVENUE • FRANKLIN PARK, IL 60131

Phone: 1-800-982-5839 or 1-847-671-4300 • Fax: 1-800-447-8329 or 1-847-671-4380 • www.sloanvalve.com